

Nombre..... Fecha.....

LA LETRA X

Completa el crucigrama con el nombre de los siguientes dibujos. Los de arriba van en horizontal y los de abajo en vertical. Luego escríbelos abajo.

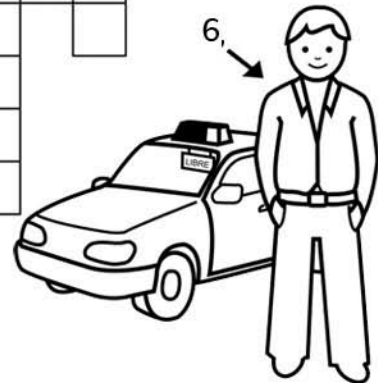
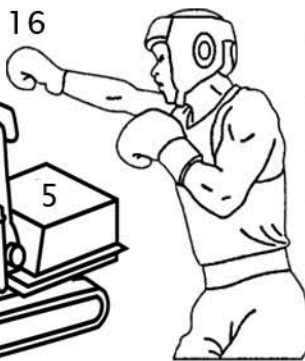
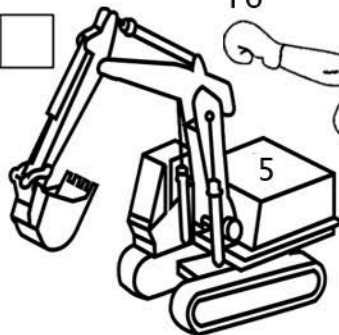
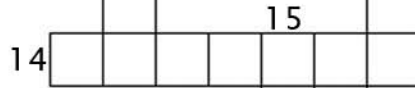
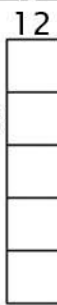
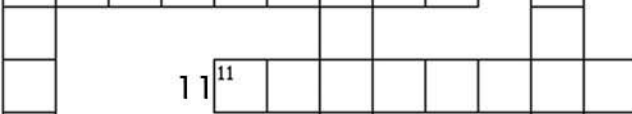
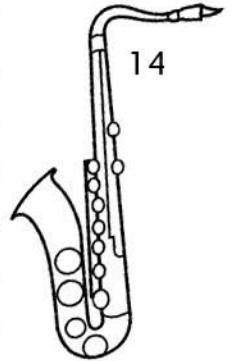
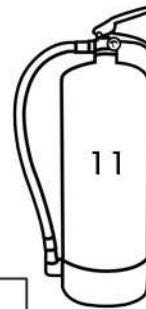
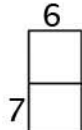
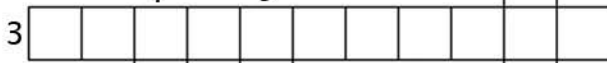
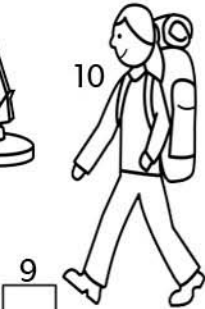
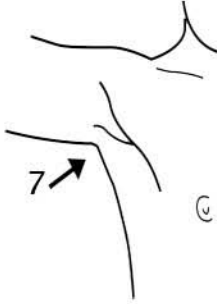
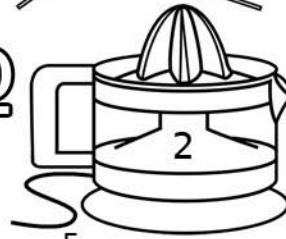
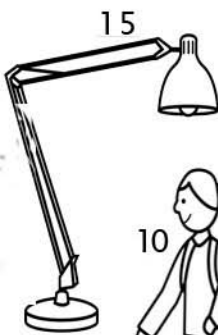
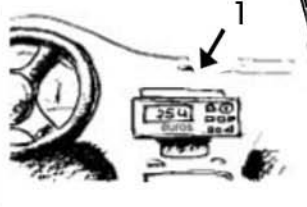
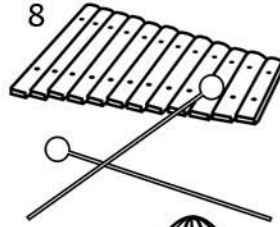
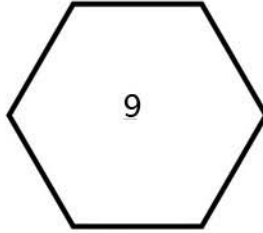

Blank lines for writing the answers to the crossword puzzle.