

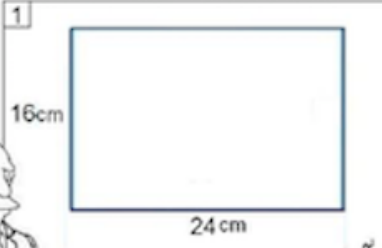

PERSONAJES DE LOS SIMPSONS

(ÁREAS DE POLIGONOS)



Calcula el área de los siguientes polígonos, el resultado te indicará el nombre de cada personaje de la serie animada de los Simpson. Creador del programa: Matt Groening, Primer episodio: 17 de diciembre de 1989.

1



Nombre:

4

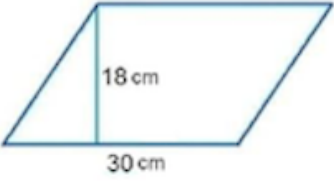

Nombre:

2

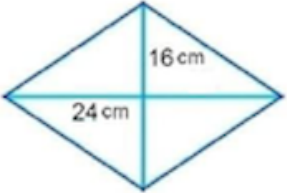

Nombre:

3

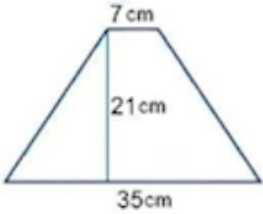

Nombre:

5

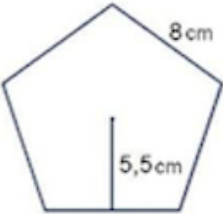

Nombre:

7

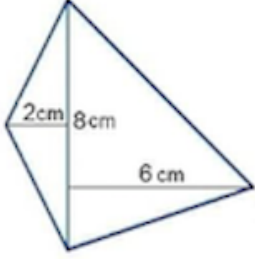

Nombre:

8

Nombre:

6

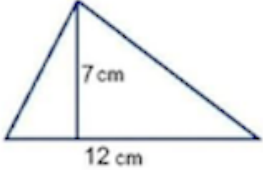
Nombre:

384 cm² Gary Chalmers

192 cm² Nick Riviera

441 cm² Jimbo Jones

32 cm² Troy McClure

42 cm² Edna Krabappel

110 cm² Ralph

121 cm² kodos

CLAVES

540 cm² Herb Powell